

Retract4 Swing-Away Joystick Arm

The **Retract4** employs a simplicity of design that offers unmatched functionality and durability. Its full 180-degree horizontal adjustment means it can be used for both left-hand and right-hand mounting and multi-position use (straight, right offset, left offset, and fold away). Also allows vertical adjustability for the joystick controller. The easy, low-pressure retractability and positioning allows chair users to get closer to tables and desks—and in and out of the chair more easily. Adaptability for most powerchairs and joystick controllers. Easy installation and virtually no maintenance. Sleek profile for easy cleaning. Full one-year warranty.

The **Retract4 Lite** model is made from plastic composites and aluminum creating a lightweight version of the original Retract4. *Note: the Retract4 Lite does not have a tension adjustment at each swivel point of the arm.*

Midline option can be added to either the Retract4 or the Retract4 Lite. The 12" midline bar attaches to the second swivel point on the arm and includes a mount for the joystick adapter. Adapter mount includes two set screws and can be adjusted horizontally on the bar's channel. A Tray Spacer is also available for an additional 3" of clearance over tray.

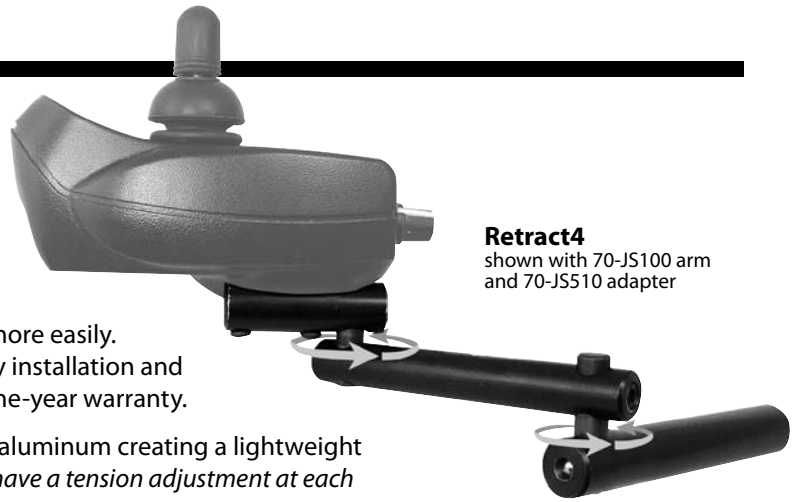

Retract4
shown with 70-JS100 arm
and 70-JS510 adapter



Part No. /Description

Retract4 — includes arm and adapter	Sugg. Retail \$246.00
Retract4 with Midline — includes arm, adapter and midline bar	\$386.00
Retract4 Lite — includes Lite arm and adapter	\$210.00
Retract4 Lite with Midline — includes Lite arm, adapter and midline bar	\$350.00
Tray Spacer for Midline	\$30.00

See next page for specific arm and adapter part numbers



Retract4 Lite
shown with 70-JS100P arm
and 70-JS510 adapter

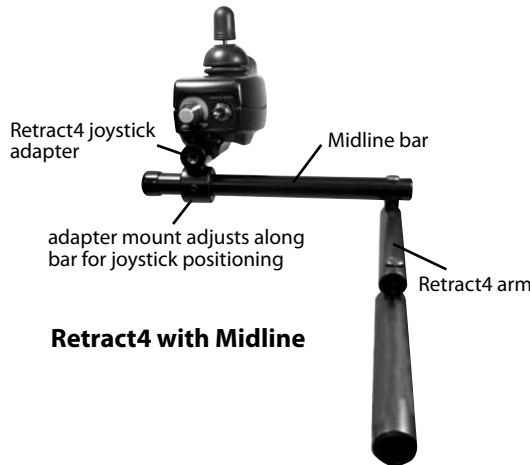

Retract4 with Midline

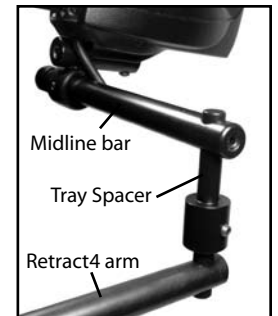

EXTENDED



RETRACTING



FOLDED

Full 180° movement allows arm to have multiple extended positions—straight, offset to left, offset to right—and adjustments. The Retract4 folds at each joint of the arm so that in the folded position it rests completely to the side of the armrest.

Retract4 Swing-Away Joystick Arm

The Retract4 consists of two components: a **swing away arm (determined by the type of powerchair)** and an **adapter (determined by the type of joystick controller)**.

ARMS - RETRACT4

70-JS100
Invacare
($\frac{7}{8}$ " receiver)



70-JS150
Quickie Rhapsody
(fits square receiver)



70-JS200
Pride, Quickie
($\frac{3}{4}$ " receiver)

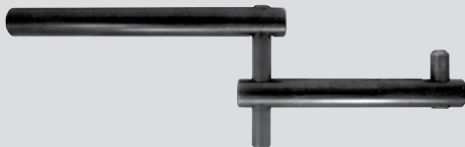

70-JS300
Permobil
($\frac{5}{8}$ " receiver)

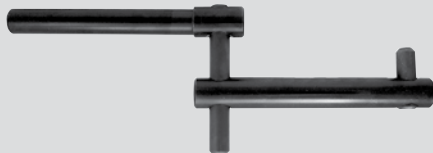

ARMS - RETRACT4 LITE

70-JS100P
Invacare
($\frac{7}{8}$ " receiver)



70-JS150P
Quickie Rhapsody
(square receiver)



70-JS200P
Pride, Quickie
($\frac{3}{4}$ " receiver)



MIDLINE OPTION

Midline Bar
fits Retract4 and Retract4 Lite



70-JSML105
Midline Tray Spacer



ADAPTERS - RETRACT4 & RETRACT4 LITE

70-JS500
Remote Plus

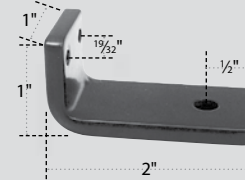

70-JS510
SPJ, SPJ+, MPJ+, Mark4,
Mark5, Mark6, Dynamic
Shark, Flight

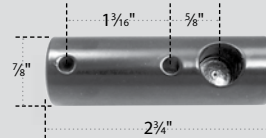

70-JS520
VSI, VS2, VR2, Q-Logic,
GC, R-Net, NE+

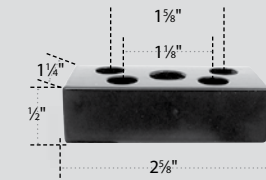

70-JS530
Qtronix

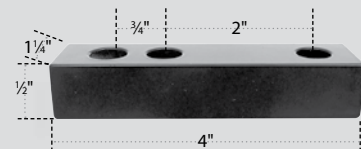

70-JS540
Delphi

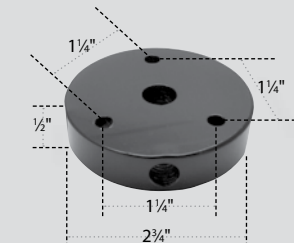

70-JS550
PGDT Pilot

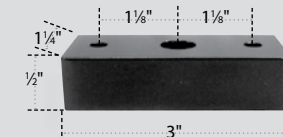

70-JS570
Micro Drive

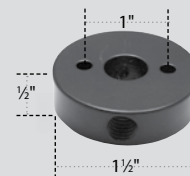

We can help select the appropriate arm and adapter for your chair and controller – call 800-492-7371.